

INSTALLATION INSTRUCTIONS TOP MOUNT SINK CH366

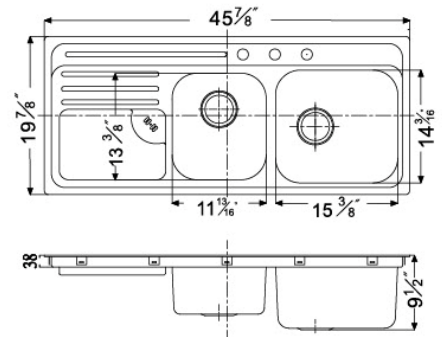

These instructions are for installing *Dawn.* top mount sink CH366.
Please read all instructions carefully before starting the installation.

TABLE OF CONTENTS

Preparation	2
Materials & Tools	2
Parts	3
Installation	4
Maintenance	7
Return Policy	8

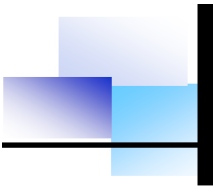

**TOP MOUNT SINK CH366
INSTALLATION INSTRUCTIONS**

PREPARATION

● **Before You Begin**

Before installing any Dawn product in your new or remodeled kitchen, you should make sure that you are in compliance with all local plumbing codes.

● **Check The Accessory Items**

Before installation, please check the condition of the product and, if appropriate, its components. If there is any problem with the product and/or its components, please contact the store you purchased it from for a replacement. As soon as you have inspected your product, please return it to its original packaging until you are ready to install it.

● **Handle With Care**

Your stainless steel sink may be very heavy and may possibly require more than one person to lift it. To protect its finish and avoid damage before and after installation, please handle your sink with care. For care and cleaning tips on Dawn Stainless Steel Sinks after installation, please refer to the *Maintenance* part in this instruction guide.

MATERIALS & TOOLS

Mounting Clips supplied by Dawn
Eye Protection (Safety Glasses)
Tape Measure
Pencil
Saw
Drill and Drill Bit
Framing Square
Silicone Adhesive Sealant
Pipe Wrench
Plumbers Putty
Denatured Alcohol
Other tools as needed

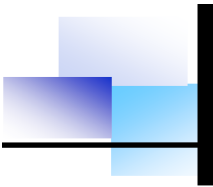

TOP MOUNT SINK CH366
INSTALLATION INSTRUCTIONS

PARTS

Drain Parts supplied by Dawn

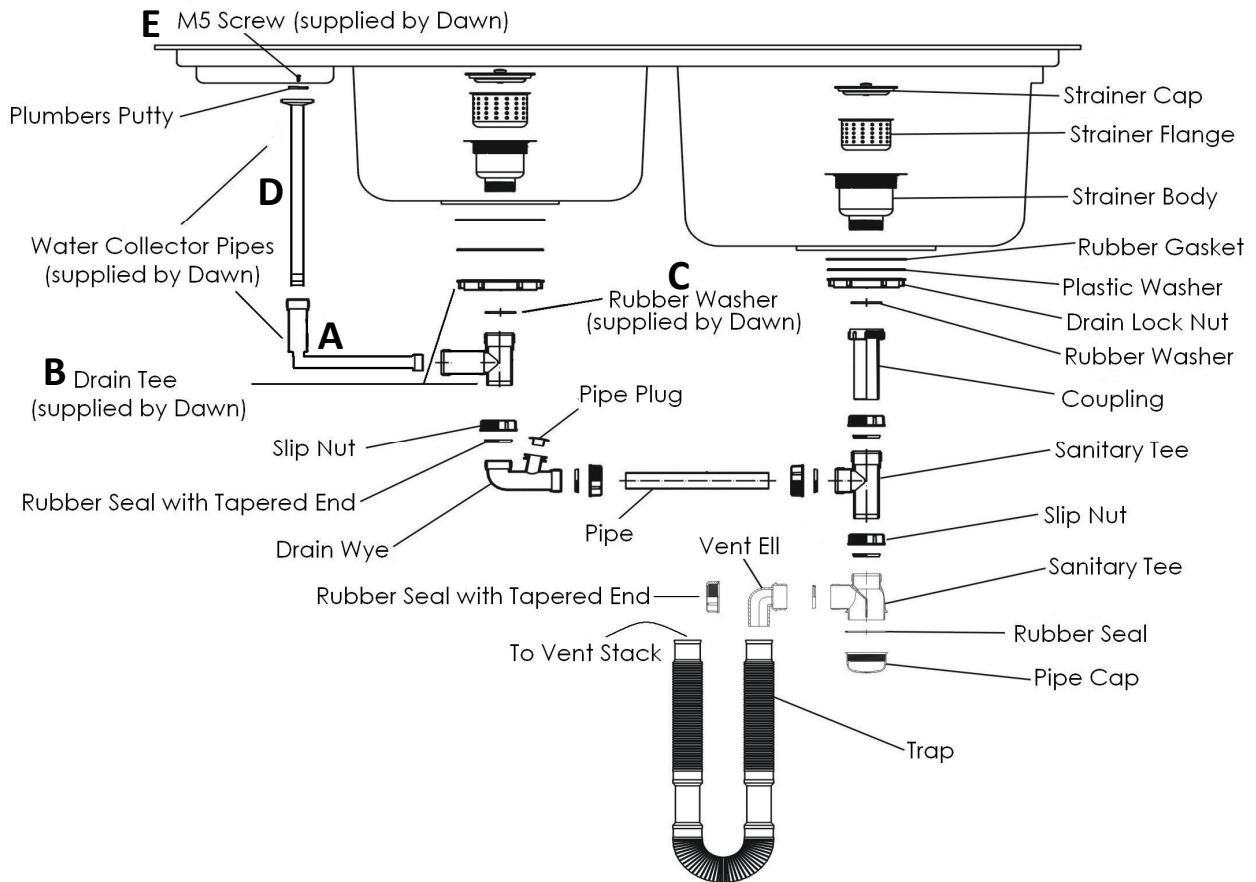
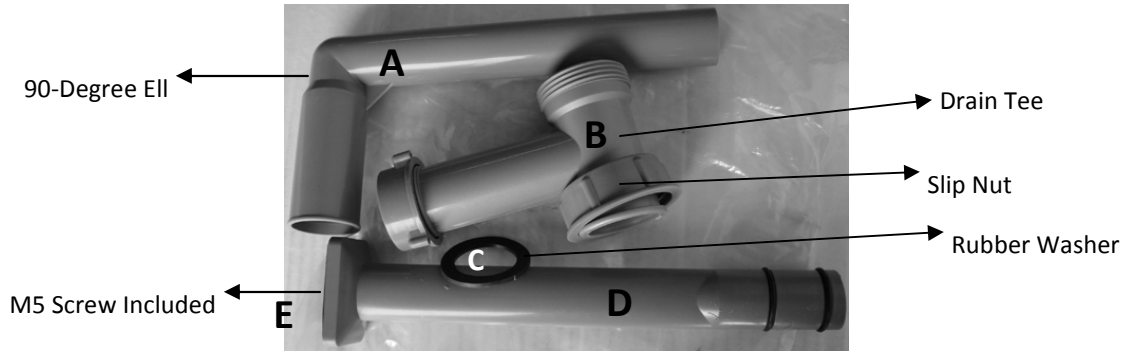

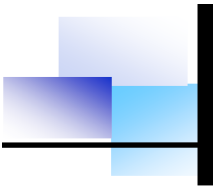

**TOP MOUNT SINK CH366
INSTALLATION INSTRUCTIONS**

INSTALLATION

IMPORTANT: The installer maintains responsibility for installing the product safely.

● **STEP 1: Install Drain Parts And/Or Strainer**

Assemble the drain parts. Apply proper amount of plumbers putty on the square end of D and fasten it to the screw hole on the left bottom of the sink with the M5 screw (E). Insert the other end of D into the shorter part of A and insert the longer part of A into the longer part of B. Make sure the slip nut end of B is on top, put C inside the slip nut, and fasten it to the bottom of the strainer tail piece.

Install the rest of the drain and/or strainer from top to bottom as shown in the following figure. Make sure to install all rubber gaskets to prevent water leakage. Run water into the sink and check for leaks. The total height of the assembled drain is approximately 300mm.

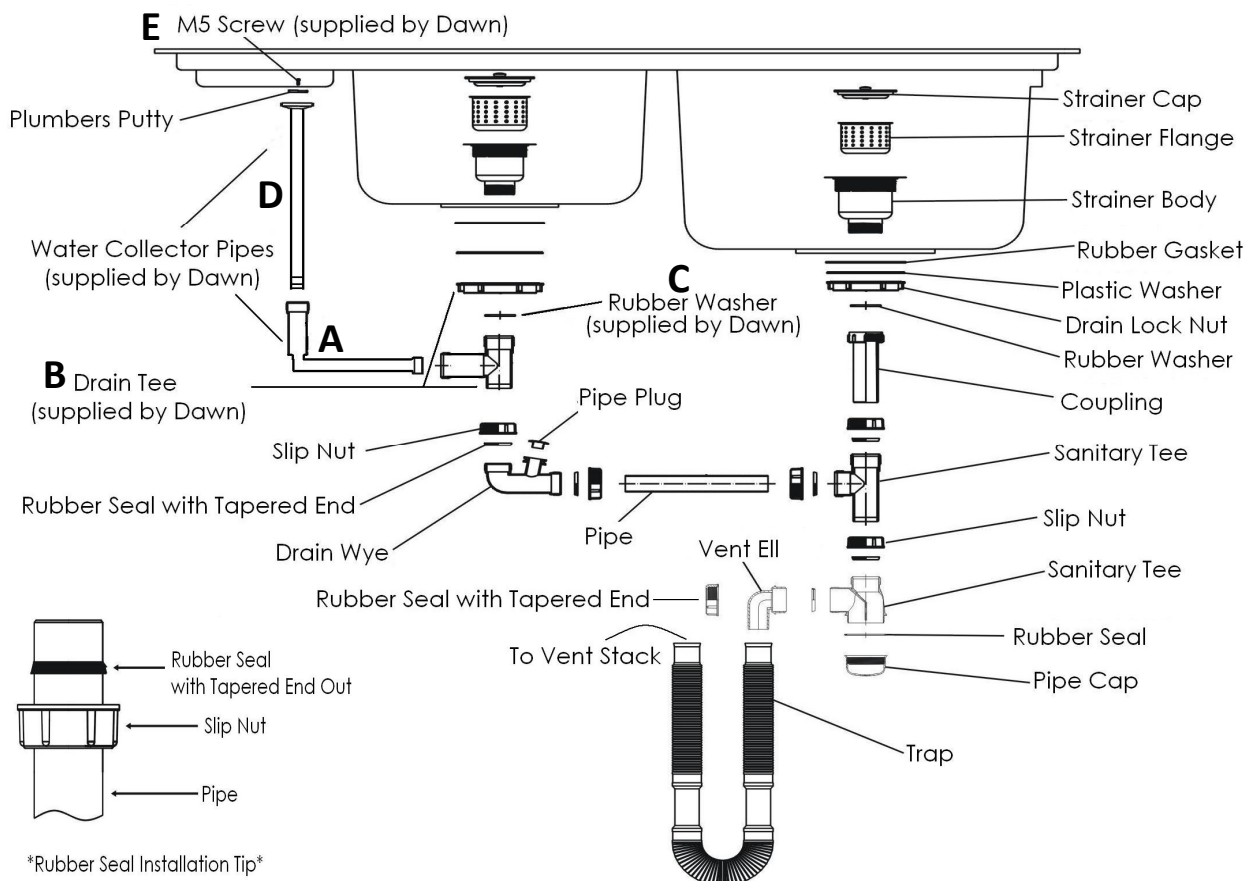

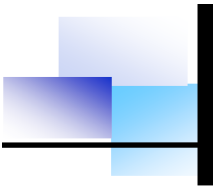

**TOP MOUNT SINK CH366
INSTALLATION INSTRUCTIONS**

INSTALLATION

IMPORTANT: The installer maintains responsibility for installing the product safely.

● **STEP 2: Create A Cutout Template**

Measure and mark the centerline of the sink position and alignment with cabinet and countertop. To create a template, place the sink upside down on the countertop and draw around it with a pencil to make the sink outline. Remove the sink. Draw another line 5/8" (15mm) inside the sink outline, and this line will be the sink cutout line.

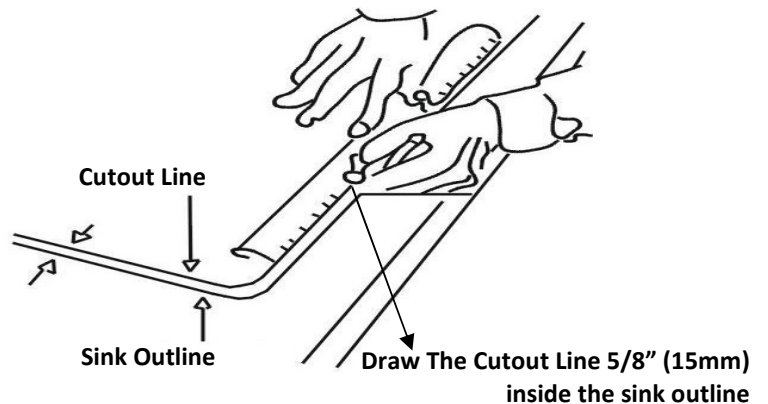
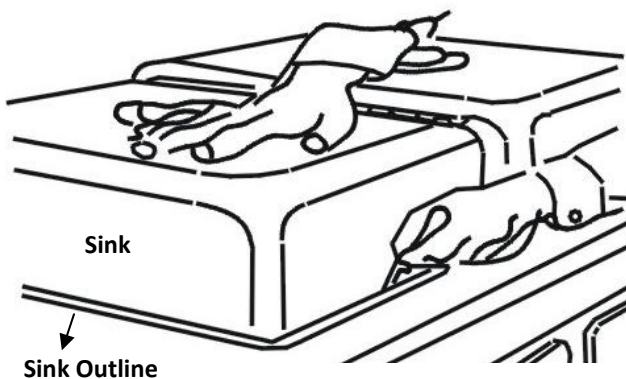

● **STEP 3: Make The Sink Cutout**

Drill a 3/8" (10mm) diameter hole on the inside of the cutout line. Insert the saw blade into the hole and cut along the cutout line to create a precise opening on your countertop. Trim and smooth the edge of the opening with sandpaper.

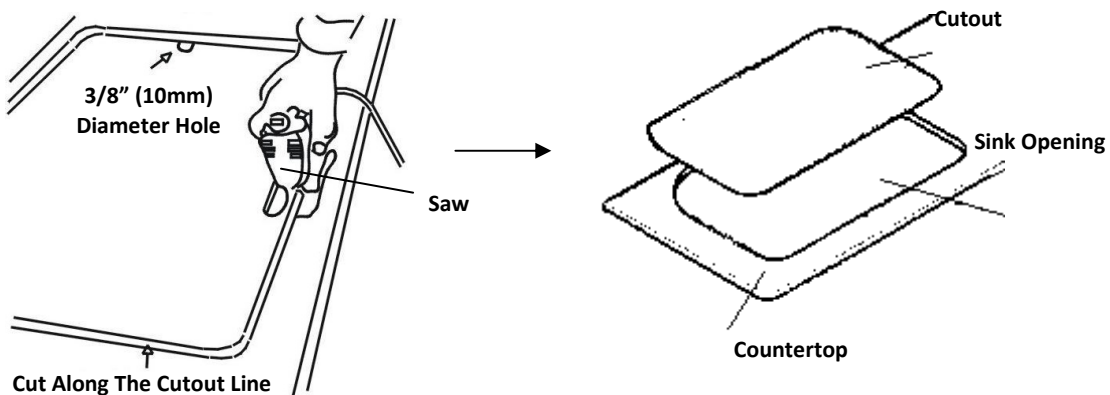

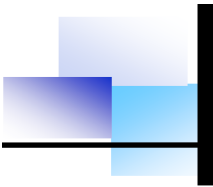

TOP MOUNT SINK CH366
INSTALLATION INSTRUCTIONS

INSTALLATION

IMPORTANT: The installer maintains responsibility for installing the product safely.

● STEP 4: Install The Top Mount Sink

Insert the sink into the opening and examine the fit. Make sure the sink is aligned with the opening and is well supported by the countertop. Remove the sink and adjust the opening if necessary. If your sink comes ready to receive the faucet, install the faucet and drain now. Clean the countertop with denatured alcohol. Apply a 1/8" (3.2mm) to 1/4" (6.4mm) bead of silicone sealant all the way along the outside of the opening without missing any area.

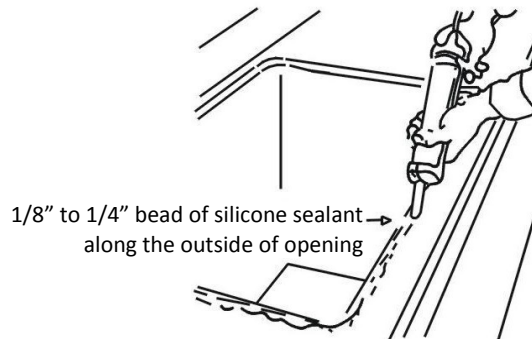

NOTE:
Too much silicone sealant could result in loose alignment between the sink and the countertop.

To install the sink, first insert the sink into the opening by attaching the bottom rim of the sink to the countertop. Make sure the rim sits on and covers the silicone sealant. Then, place the sink completely into the opening and make sure the sink fits properly to the countertop. Verify the sink is level both front to back and left to right. Immediately wipe away any excess sealant with a damp cloth.

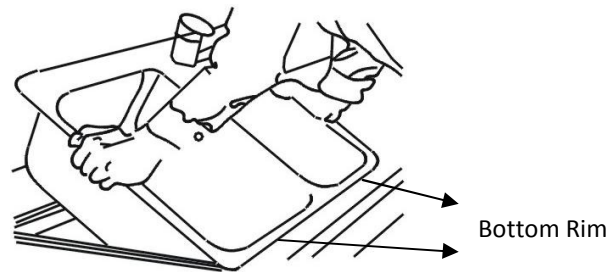

● STEP 5: Install The Mounting Clips

Hook the mounting clips from the underside of the sink onto the lip on the back of the sink rim. Tighten the screws to pull the sink down tight against the countertop. Do not overtighten.

NOTE: Tightening the mounting clips may cause the silicone sealant to squeeze out from under the sink lip. Wipe away the excess sealant with a damp cloth.

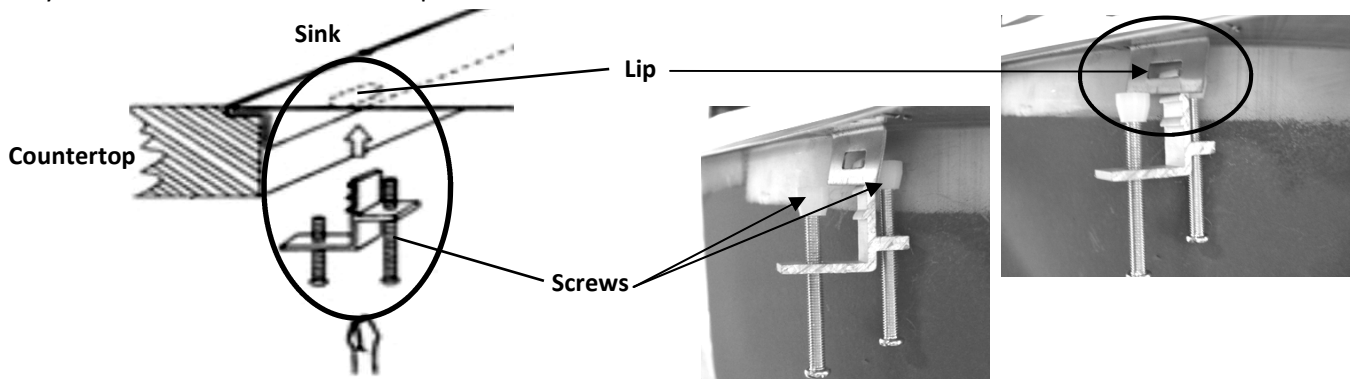

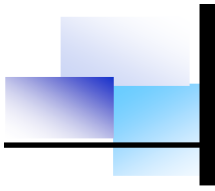

**TOP MOUNT SINK CH366
INSTALLATION INSTRUCTIONS**

MAINTENANCE

Care and cleaning instructions for Dawn stainless steel sinks:

Clean regularly with clean water and/or a mild detergent solution applied with a soft cloth or sponge. Rinse thoroughly and towel dry after every use to prevent water spots and mineral deposits from building up on the surface of the sink. Deep clean once a week with an approved cleanser and a soft cloth or sponge rather than an occasional aggressive single cleaning - be sure to rub in the direction of the finish lines. Cleaners should state approved or suitable for stainless steel.

- **Scratches**
Like most metallic surfaces, stainless sinks will get scratches. These are usage scratches and will blend in with the overall finish of your sink over time. There are steps that can be taken to reduce appearance of scratches:
Use a nylon pad with an iron free abrasive polishing compound. Follow the direction of the original polish lines to blend out the scratch in a small area. Be cautious not to overdo the process. A too aggressive procedure will result in a bright spot.
- **Water Quality**
Regular routine cleaning can usually prevent lime scale deposits from hard water. Do not allow excessive build up before treating. Soaking in a 25% vinegar solution can treat hard water spots. Periodically rub with a synthetic scouring pad, then rinse and towel dry.
- **Rust Marks**
If you develop rust marks due to presence of or contact with iron containing materials, swab with a sponge wetted with a dilute solution of (10-15%) nitric acid (HN03) and follow with routine cleaning. Avoid prolonged contact of iron containing materials with stainless steel.

Do's and Don'ts

- Do regular routine cleaning rather than an occasional aggressive single cleaning.
- Only use propriety brands of cleaners that state "SUITABLE FOR STAINLESS STEEL".
- Always rinse and dry as the final step in a cleaning procedure.
- If there is any accidental contact of the sink with photographic chemicals or soldering fluxes, immediately rinse and clean the sink with water.
- Do not leave low-carbon steel or iron kitchenware in the sink.
- Do not leave rubber patches, wet sponges, cloths, cleaning pads, or dishpans in the sink.
- Do not use coarse abrasive powders, metallic scourers such as steel wool or brushes with metal bristles.
- Do not leave standing solutions of chlorine bleach and water in the sink.
- Do not allow liquid soap or other cleansers to dry on the surface of the sink.
- Do not leave food with high-salt content such as pickles, béarnaise sauce or mustard in the sink.
- Do not use cleaning products containing silver, sulfur or hydrochloric acid.
- Do not leave metal or rusted materials in the sink.
- Do not rub the sink with metal rubbing or scrubbing pads.
- Do not use the sink as a cutting board.

LEGAL DISCLAIMER:

- This instruction guide is done as a public service to customers of Dawn Kitchen & Bath Products, Inc. ("Dawn"). For special situations or further assistance, please consult professionals.
- All products should be inspected by customers upon receipt and before any preparation for installation. Any defective product should be reported immediately and should NOT be installed.
- Requirements may vary for installation in a granite, marble, stone, or butcher block countertop.
- Installation by professional installers is highly recommended. Dawn assumes no liability for any damages incurred through the use of information provided in this publication or the installation.

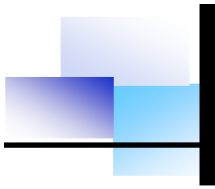

**TOP MOUNT SINK CH366
INSTALLATION INSTRUCTIONS**

WARRANTY

All Dawn products carry limited lifetime warranty unless otherwise noted. Dawn products have been manufactured and tested to the highest quality standards by Dawn Kitchen & Bath Products, Inc. ("Dawn"). Dawn warranties are limited to Dawn products purchased and installed in the United States.

Limited Lifetime Warranty

Dawn Kitchen & Bath Products, Inc. warrants its products to be free from manufacturing defects in material and workmanship during normal residential use for as long as the original consumer purchaser owns his or her home. This warranty only extends to the original consumer purchaser and this warranty is non-transferable. If any defect is found in normal residential use, Dawn Kitchen & Bath Products, Inc. will, at its election, repair, provide a replacement part of product, or make appropriate adjustment at no charge (excluding labor charges and other incidental or consequential costs). Damage to a product caused by accident, misuse, or abuse is NOT covered by this warranty. Improper care and cleaning will void the warranty. If Dawn is unable to provide a replacement and repair cannot be made, Dawn may elect to refund the purchase price to the original consumer purchaser in exchange for the return of the product. (IMPORTANT: The original consumer purchaser should be responsible for inspecting products upon receipt. Any defective product should be reported immediately and should NOT be installed.)

One-Year Limited Warranty

Dawn sink and kitchen accessories are warranted to be free of defects in material and workmanship for one year from date of purchase. Dawn will, at its election, repair, replace or make appropriate adjustment where Dawn inspection discloses any such defects occurring in normal usage within one (1) year after purchase. Dawn is not responsible for removal or installation costs.

DAWN WARRANTIES DO NOT COVER, AND DAWN DISCLAIMS ANY LIABILITY FOR:

- Conditions or damage NOT resulting from defects in material or workmanship.
- Conditions or damage resulting from:
 - Normal wear and tear, improper installation or maintenance, misuse, abuse, negligence, accident or alteration.
 - Use of abrasive cleaning products or the use of the product in any manner contrary to the product instructions.
 - Conditions in the home such as excessive water pressure or corrosion.
- Labor, shipping or other costs for removal, installation, replacement or return of product for warranty service.
- Parts, accessories, connected materials or related products that are not manufactured by Dawn.

Dawn reserves the right to inspect any Dawn product reported to be defective prior to any repair or replacement. Repair and replacement costs EXCLUDE shipping, labor, and consequential expenses. To obtain warranty service contact Dawn either through your Dealer, Plumbing Contractor, Home Center or E-tailer, or by contacting Dawn at the contact information listed below. Proof of purchase (original sales receipt) and description of problem must be provided with all warranty claims.

RETURN POLICY

Dealers may return new, uninstalled items sold and fulfilled only by Dawn Kitchen & Bath Products, Inc. for a full refund within 30 days of purchase. Items must be returned in its original packaging. Dawn will pay for return shipping and handling costs only when the return is a result of manufacturer defect. Dealers may also exchange an item that is in "as new" condition with original packaging within 30 days of purchase. Returns and exchanges after 30 days of purchase may be accepted with a minimum 15% restocking and handling fee.

To request a return or exchange:

- Contact Dawn Customer Service to request a return and obtain a Return Merchandise Authorization (RMA) number. If an exchange is necessary, place an exchange order at this time.
- Send the item, along with a copy of the original invoice and all of the original packaging and material (including instruction manual and parts, as applicable) to the below address. Write the RMA number on the cover of the package.

Dawn Returns & Exchanges
ATTN: RMA # _____
27688 Industrial Blvd
Hayward, CA 94545

- Refunds will be credited to the dealer account within 10 business days of return receipt. All returned items are subject to inspection upon receipt. Physically damaged items that are not in sellable condition are non-refundable.
- Return/exchange shipping fees will be at the expense of the purchaser unless the return/exchange is a Dawn error.